



www.facebook.com/MitsubishiMotors.en



www.instagram.com/mitsubishimotorsofficial



www.youtube.com/user/MitsubishiMotorsAd



L200

RECYCLING OF OLD VEHICLES

It is our duty to protect the environment.

Mitsubishi Motors designs and produces high quality vehicles and components aiming to provide our customers with durable motor vehicles, and excellent services to maintain your vehicle in an optimum running condition. We have the highest respect for the environment and use materials which may be recycled and re-used after your Mitsubishi Motors vehicle has come to the end of its economical life. After a long working life we will take your vehicle back and recycle it in an environmentally friendly manner in accordance with the EU Directive on End-of-Life Vehicles and any applicable national statutory provisions.

All Mitsubishi Motors vehicles (up to 3.5t GVW) sold after 1st July 2002, will be taken back free of charge from the last owner, at one of the designated take back points, provided the vehicle contains all major components and is free of waste. From 1st January 2007, this applies to all Mitsubishi Motors vehicles irrespective of the sold date. A network of collection points is available to receive Mitsubishi Motors End-of-Life Vehicles,

to ensure your vehicle will be recycled in an environmentally friendly manner. At the same time, the possibilities for the recycling of vehicles and vehicle components are continually being evaluated and improved, aiming to the achievement of even higher recycling percentages in the future.

The European End-of-Life Vehicles Directive and the free take back of End-of-Life Vehicles are applicable in all European Union member states. The transposition of the End-of-Life Vehicles Directive into national law in each member state might not have been completed at the time of putting this publication to print.

Please refer to www.mitsubishi-motors-europe.com and select the web site of the Mitsubishi Motors service network in your country of residence, or call the National Mitsubishi Motors Customer Assistance Centre for further details.

OUTSTANDING AFTER SALES FOR CAREFREE MOTORING

Around 2,500 Mitsubishi Motors Authorised Service Points in Europe are committed to helping you wherever you are.

PROFESSIONAL SERVICING

Even new cars require regular maintenance and servicing. Not just to guarantee your mobility, but also for the safety of you and your passengers. Trained professionals using specialist diagnostic equipment and original parts at your Mitsubishi Authorised Service Point are ready to oblige. You'll be advised about the cost beforehand, so there will be no unpleasant surprises when you return to pick up your vehicle.

MITSUBISHI MOTORS GENUINE PARTS

Even the smallest technical faults can lead to accidents. Therefore, all Mitsubishi Motors Genuine Parts have been developed and tested to stringent quality standards. It is recommended to use Mitsubishi Motors Genuine Parts in order to maintain the safety and integrity of your vehicle and that of your passengers. Mitsubishi Motors Genuine Parts are available at all Mitsubishi Authorised Service Points. We are proud to regularly score top in After Sales quality surveys.

COMPREHENSIVE WARRANTY – OBVIOUSLY

New Mitsubishi vehicles come standard with a comprehensive 5*-year warranty or up to a maximum of 100,000 km (62,500 miles), whichever comes first. The anti-corrosion perforation warranty covers rusting through for the first 12* years. The reliability statistics for Mitsubishi vehicles are impeccable, but in the unlikely event that you do need help, we offer MAP.

*Depending on vehicle model and market, for details please refer to your Mitsubishi Service Booklet

MITSUBISHI MOTORS ASSISTANCE PACKAGE (MAP) – FREE BREAKDOWN ASSISTANCE

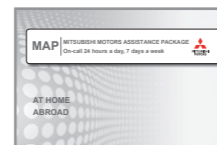

In order to demonstrate our commitment to your mobility and the faith we have in the reliability of our vehicles, you will receive a free MAP card valid for 5 years with your new Mitsubishi. With the MAP card in your pocket, your mobility is guaranteed in more than 30 countries throughout Europe.

Should you ever need assistance in the event of breakdown, accident, theft or vandalism – wherever you are, 24 hours a day, 7 days a week – just call the number on your card and the problem will be fixed on the spot. If it's more serious, your car will be taken to the nearest Mitsubishi dealer and you'll be offered services such as a hotel, continuation of journey, a replacement car and vehicle repatriation.

MITSUBISHI MOTORS CORPORATION
www.mitsubishi-motors.com

MITSUBISHI MOTORS EUROPE B.V.
www.mitsubishi-motors-europe.com

Some equipment may vary according to country.
Please consult your local Mitsubishi Motors dealer/distributor for details. All rights reserved.



Power Tool for Life.



4WD Instyle Double Cab / Sterling Silver Metallic [U25]

Note: Equipment may vary by market. Please consult your local Mitsubishi Motors dealer/distributor for details.



Left: 4WD Instyle Double Cab / Titanium Grey Metallic [U17]
 Right: 4WD Instyle Club Cab / Quartz Brown Metallic [C06]

A Stylish Show of Strength.

Feel the power. Feel the handling.
 Feel a new level of comfort in an entirely new class of vehicle.
 The L200, it's all truck and all car and it changes
 the way you think about getting from one place to another.



LED daytime running lamp



Outstanding aerodynamic performance

The L200 is streamlined based on advanced computer simulation to slip through the wind with a class-leading 0.40* Cd that lowers noise and raises fuel efficiency while enhancing both acceleration and handling stability.

* According to internal test results.



4WD Instyle Double Cab / Leather interior



4WD Instyle Double Cab / Leather interior

Wide Open Spaces

Travel comfortably in the L200 Double Cab, which offers class-leading space and leg-stretching relaxation. Enhanced high-quality seating, raises driving pleasure for all occupants. Strategically placed sound insulation and vibration damping material further contribute to a quiet, comfortable ride. Everything you need, including convenient storage features, is here to support a pleasurable journey.

Class-leading cabin length

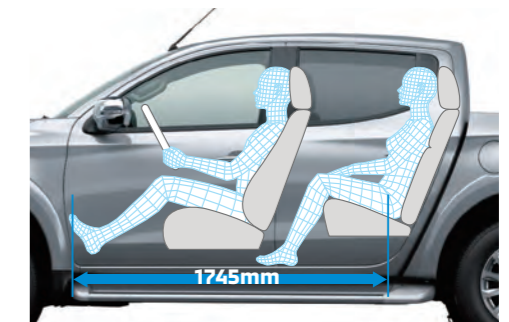

Luxurious front seats



Quieter, more relaxing ride

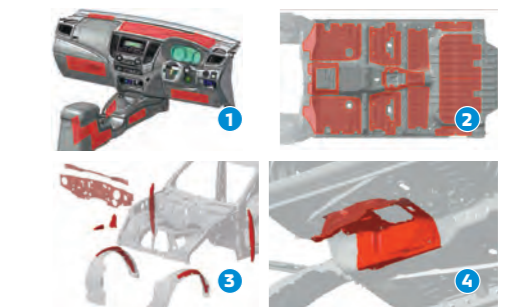

- 1 Instrument panel sound absorbing material
- 2 Floor damping material
- 3 Dashboard and fender noise insulation
- 4 Backbone sound absorbing material

* Equipment may vary by model.

Powerful Efficiency

Remarkable fuel economy. Extremely low CO₂ emissions. Two exceptionally lightweight 2.4-litre turbo diesel engines produce all the power and efficiency you demand of a pickup, courtesy of leading advances including an aluminium cylinder block and precision common rail direct injection system.

DI-D
COMMON RAIL
Direct Injection Diesel



High fuel efficiency, low CO₂ emissions and plenty of power

2.4-litre MIVEC*16-valve Intercooled Turbocharged DOHC Common Rail DI-D High Power

The MIVEC diesel engine dramatically raises fuel efficiency and lowers CO₂ emissions while delivering powerful response with 133kW (3500rpm) output and 430N·m (2500rpm) of torque.

* MIVEC (Mitsubishi Innovative Valve timing Electronic Control system)

430N·m

2.4-litre turbo diesel engine

Thanks to a lightweight all-aluminium alloy engine block and precision common rail direct injection system, this engine delivers remarkable fuel efficiency, low CO₂ emissions and powerful response with the spirited output and robust torque you need for serious work and play.

Turbocharger

The variable-geometry turbocharger features less rotational moment of inertia of the compressor and turbine to produce gutsier low-rev torque and smoother high-rev response. An intercooler optimally cools the air to further improve combustion efficiency.

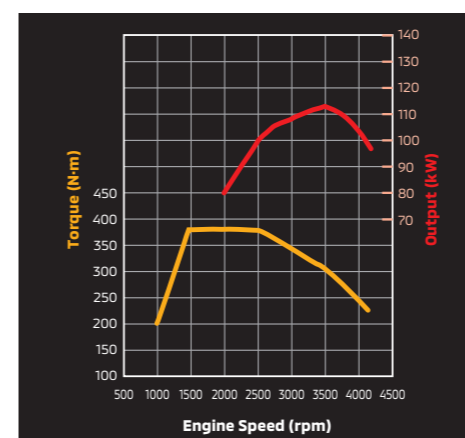

2.4-litre Turbocharged DOHC DI-D Standard (113kW/3500rpm, 380 N·m/1500-2500rpm)

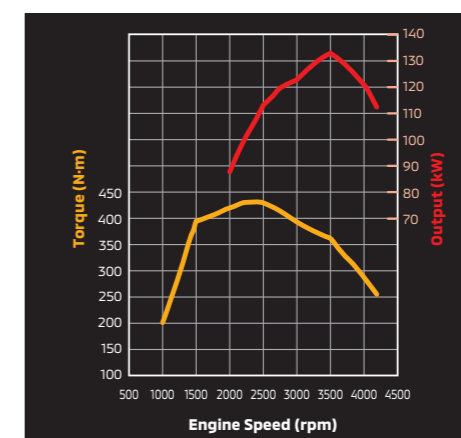

2.4-litre MIVEC Turbocharged DOHC DI-D High power (133kW/3500rpm, 430 N·m/2500rpm)

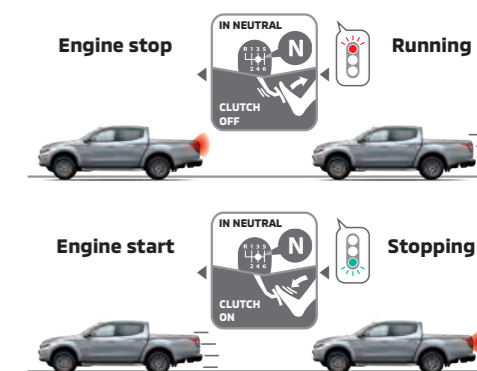

Auto Stop & Go [AS&G]

Auto Stop & Go [AS&G] reduces fuel consumption and CO₂ emissions by automatically shutting off the engine when the vehicle is stationary, such as when waiting at traffic lights. The engine restarts immediately when your foot presses the clutch pedal (in neutral).



Paddle shifters

Sporty paddle shifters let you shift gears with a press – without removing your hand from the steering wheel.



5-speed automatic transmission with Sport Mode

To enjoy driving ease without sacrificing sportiness, choose the smooth-shifting 5-speed automatic transmission. Its Sport Mode lets you shift up or down with a flick of the lever for sporty, manual-like driving pleasure.



6-speed manual transmission

Six manual speeds give you total control of power delivery to match driving conditions. The solid stick shift with shorter, more satisfying shift stroke combines with somewhat lighter clutch control for easier operation. An overall wide ratio also enhances fuel efficiency.

Safety

RISE body

Collision safety performance is significantly enhanced by Mitsubishi Motors' RISE (Reinforced Impact Safety Evolution) body, which efficiently absorbs energy and maintains high cabin integrity in the event of a collision.



Rigid lightweight body

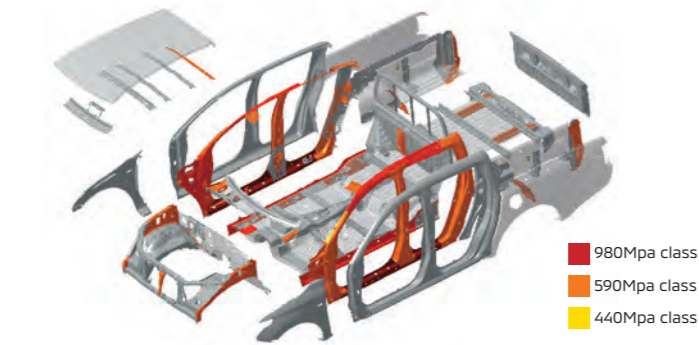

The body is extremely sturdy and lightweight due to the generous use of high tensile strength steel plates that also contribute to a high level of collision safety.



7 SRS airbags

In the event of a collision, seven SRS airbags help protect you and your passengers by absorbing the force of impact. The system includes front airbags, front side airbags, curtain airbags and a driver's knee airbag.

Note: Airbags are part of a Supplemental Restraint System [SRS]. To decrease the risk of injury from a deploying airbag, always wear your seat belt, sit upright in the middle of the seat and do not lean against the door. Always place children 12 and under in the rear seat and use appropriate child restraints. Never place a rear-facing infant restraint in the front seat. Please see the owner's manual and the instructions provided with your child restraint for additional information.

Note: Equipment may vary by market. Please consult your local Mitsubishi Motors dealer/distributor for details.



Adjustable Speed Limiter

The Adjustable Speed Limiter prevents the vehicle from exceeding the speed you select in most situations. You may need to apply the brakes to prevent the speed from being exceeded when driving downhill. A warning displays and an alarm sounds to alert you if the set speed is exceeded.



Double pretensioner (Driver's seat)

Pretensioners

Pretensioners on the front seatbelts automatically tighten the belts in the event of a frontal collision to help restrain the driver and front passenger and reduce the force of impact when the front airbags are deployed.

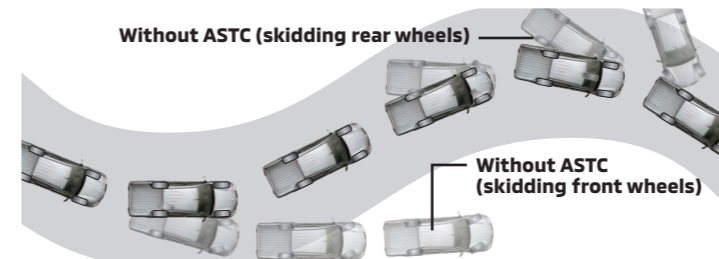

Active Stability & Traction Control [ASTC]

Active Stability & Traction Control independently regulates braking force to the wheels during cornering to help maintain excellent vehicle stability when needed. It also optimises traction to prevent loss of torque whenever wheel spin is detected by controlling engine output and applying brake force to the spinning wheels.

Note: The control capabilities of ASTC are supplemental only. Please drive safely and never rely solely on these functions while driving. Be sure to use the same specified type and size of tyres on all 4 wheels. Do not install any aftermarket limited slip differential on your vehicle. Please see the owner's manual for additional information.

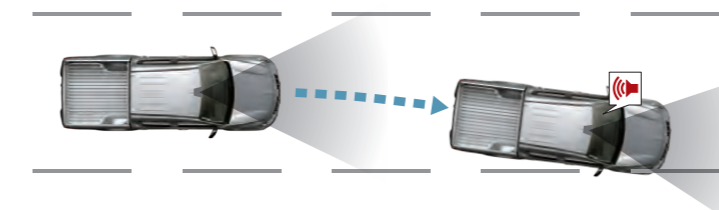

Lane Departure Warning System [LDW]

If you start drifting from your lane when travelling over 65km/h, the LDW system detects it via windshield camera and alerts you with an audible alarm and warning lamp.

Note: Lane Departure Warning is not designed to lessen risks associated with not looking ahead carefully (attention drawn to something on the side, absentmindedness, etc.) or poor visibility caused by bad weather etc. Keep steering your vehicle correctly and drive safely. The system may not be able to detect the lane correctly in some conditions. Please see the owner's manual for additional information.

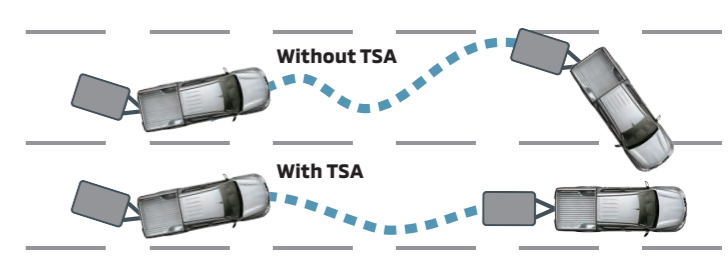

Trailer Stability Assist [TSA]

TSA increases stability when towing. If vehicle swaying is detected, it automatically controls engine power and the braking force at each wheel to stabilise the vehicle and trailer.

Note: The control capabilities of Trailer Stability Assist [TSA] are supplemental only. Please drive safely and never rely solely on these functions while driving. Due to the slippery road surface, heavy side wind, inappropriate weight and positioning of luggage, and/or driving at high speed, the TSA system may fail to secure stability. Please see the owner's manual for additional information.

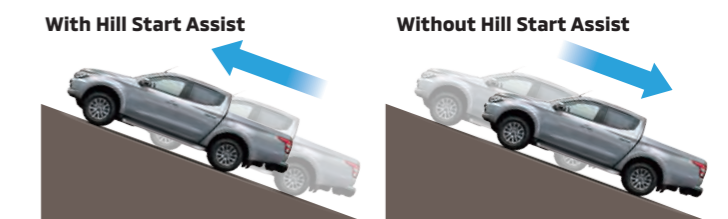

Hill Start Assist [HSA]

When starting on a steep slope, HSA helps prevent you from rolling backwards while you release the brake by maintaining the braking force for up to two seconds until the accelerator is applied.

Note: Hill Start Assist [HSA] is not a substitute for safe driving. Never rely solely on this function while driving on steep roads. Your vehicle may move backwards if the brake pedal is not sufficiently depressed, or if the road is very steep or slippery. This function is not designed to keep the vehicle stopped in place on uphill slopes for more than 2 seconds. Do not rely on this function to maintain a stopped position as an alternative to depressing the brake pedal. Please see the owner's manual for additional information.



All-terrain confidence

Because challenges come in all shapes and sizes, the L200 is designed to climb up, over, around and through the toughest terrain.



Drivability is improved both on and off the road. Forward visibility has also been improved through refinements to the hood and wipers.

- Indicated angles are valid when 245/65R17 tyres, plate-type side steps and stylish-type rear step bumper are mounted.
- Departure angle is 25° without stylish-type rear step bumper.
- Indicated angles are also valid when 205R16C tyres are mounted without side steps (ramp break-over angle is 23° with side steps).

Robust Handling

The L200 is built for maximum stability and traction. The rugged frame and aerodynamically contoured body contribute to solid handling and stable highway performance. Reliable 4WD traction combines with an advanced suspension to keep you in touch with surface conditions so you stay in firm control.



EASY SELECT 4WD







Switch from smooth 2WD (2H) highway performance to rugged 4WD (4H) traction while driving at up to 100km/h. Transfer torque to all four wheels with a flick of the drive mode selector dial in the 4H mode or by entering the 4L mode, which provides lower gear ratios and higher torque for slower speed driving in rough terrain.

Note: Easy Select 4WD lets you shift between 2H and 4H modes at speed up to 100km/h. Vehicle must be stopped when switching between 4H and 4L. Please see the owner's manual for additional information.

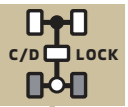
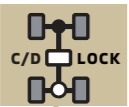
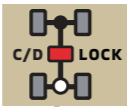

SUPER SELECT 4WD-II

Using the drive mode selector dial, you can switch between 2WD (2H) and 4WD (4H, 4HLc) with shift-on-the-fly convenience at up to 100km/h. When the going gets rough, lock the centre differential by entering the 4HLc setting for rugged terrain or the 4LLc setting for inclines, mud and snow.

 <p>2H</p>	 <p>4H</p>	 <p>4HLc</p>	 <p>4LLc</p>
 <p>For normal road conditions</p>	 <p>For rough roads and hazardous conditions</p>	 <p>For rugged terrain with low-grip surfaces</p>	 <p>For steep hills, mud, sand, deep snow, etc.</p>

Note: Super Select 4WD-II lets you shift between 2H, 4H and 4HLc modes at speeds up to 100km/h. Vehicle must be stopped when switching between 4HLc and 4LLc. Please see the owner's manual for additional information.

Rear differential lock

Locking the rear differential minimises differences in rotation between the rear wheels to ensure robust traction even on sand, mud and rocky surfaces.

Note: Rear differential lock is available when switching between 4HLc and 4LLc modes (in Super Select 4WD-II) or 4H and 4L modes (in Easy Select 4WD). Vehicle must be stopped in Rear differential lock switching.

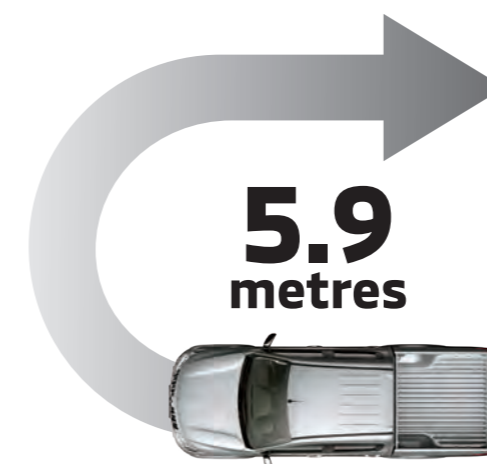

Class-leading 5.9m turning radius

The turning radius is surprisingly small for a vehicle of this size, making the L200 especially easy to park and manoeuvre.

Quick, responsive handling

Steering is sporty and responsive, requiring less effort to turn.



Rugged Reliability

The L200 is built tough to handle whatever challenges come your way. Its ample storage capacity and durability are matched by handsome styling and spacious comfort that your travelling companions will appreciate. Streamlined styling also contributes to class-leading aerodynamics and a smooth, quiet ride.

4WD Instyle Club Cab / White Pearl [W54]

Room to spare

The stylish L200 provides all the space and tough reliability you need. Its spacious cargo bed is also solidly reinforced to offer outstanding durability.

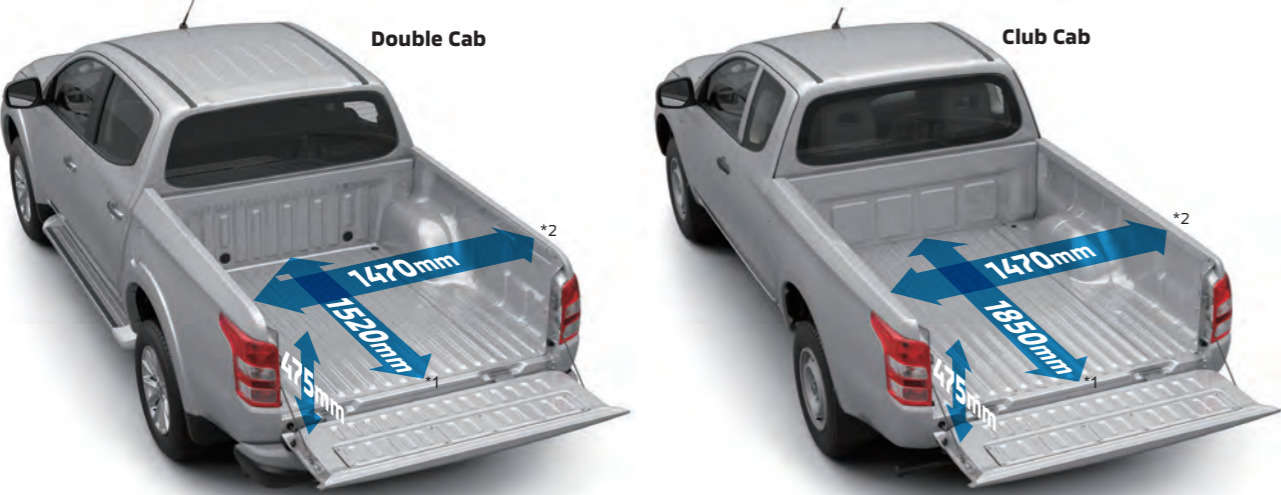

*1: Measured from bottom of bed
*2: Measured from top edges



Cargo bed inner hook x 6

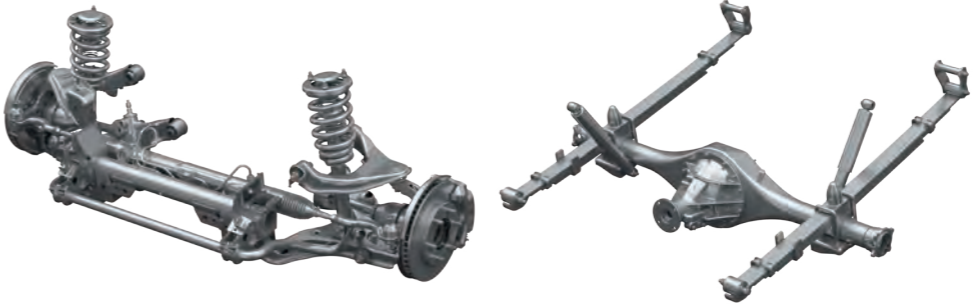

Tough suspension

The rugged suspension features double wishbones with coil springs and a stabiliser bar in front, plus no-nonsense above-the-axle leaf springs in the rear for outstanding traction. The ride is stable and comfortable for all occupants.

* Equipment may vary by model.

Durable design

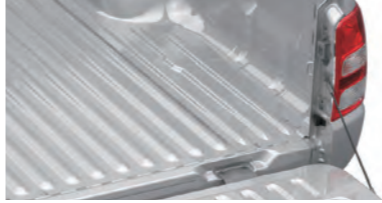

In front, a more rigid engine compartment and double striker in the hood safety mechanism contribute to enhanced durability and safety. In the cargo bed, the rear corners are specially reinforced to disperse the force of impact when cargo shifts and prevent damage such as cracks in the side panels.

Robust construction



More rigid engine compartment



Reinforced rear corners



Hood safety mechanism with double striker

Note: Equipment may vary by market. Please consult your local Mitsubishi Motors dealer/distributor for details.

Convenience

MITSUBISHI MULTI COMMUNICATION SYSTEM [MMCS]

The multifunctional navigation system clearly displays navigation and music functions on a big touch panel display with easy-to-use interface. Images from the rear-view camera can also be displayed to enhance driving safety.



Clear wide screen
The bright and wide VGA screen displays every detail at high resolution.



3D map view
Maps can be viewed with 3D landmarks when desired.

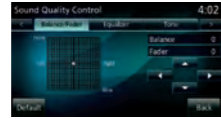

Audio system control
Various audio system features are controllable on the touch panel display.



2-screen viewing
Two screens, such as for navigation and audio, can be displayed at the same time.

Note: The information displayed varies depending on the equipment.

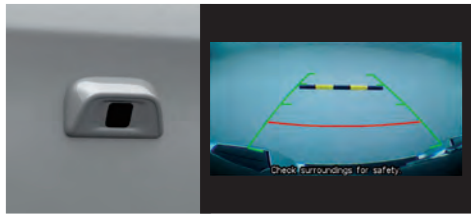

Rearview camera



USB connectivity



Hands-free Bluetooth® telephone*

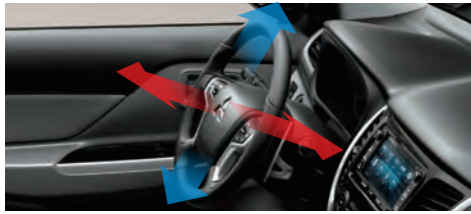

Tilt & telescopic steering



Multi-information display



Dual-zone automatic air conditioner



Keyless operation system

While carrying the key, you can press a button on the outside of either front door to lock or unlock all the doors, or press the engine switch in the cockpit to start the engine.



Auto dimming rear view mirror

This mirror automatically reduces glare from the headlights of cars behind you to maintain a clear rear view and support safer driving.

ETACS (Electronic Time and Alarm Control System)



Power window timer

Even after shutting off the engine, the power windows can be opened or closed for 30 seconds before opening the door.



Auto door relock system

Within 30 seconds of pressing the unlock button from outside the car, this system will automatically relock all the doors if none have been opened.



Headlamp auto off function

After switching off the ignition and stepping out of the car, the headlamps automatically turn off to help conserve battery power.



Auto speed adjustable wipers

In the Timing mode, the window wipers operate faster at higher vehicle speeds.

Club Cab

Inform



Invite

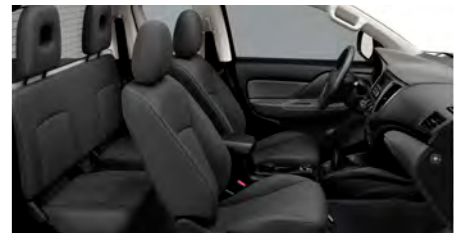

Intense



* The Bluetooth® word mark and logos are registered trademarks owned by the Bluetooth SIG, Inc. and any use of such marks by MITSUBISHI MOTORS CORPORATION is under license. Note: Equipment may vary by market. Please consult your local Mitsubishi Motors dealer/distributor for details.

Double Cab

Inform



Club Cab

Instyle



Invite

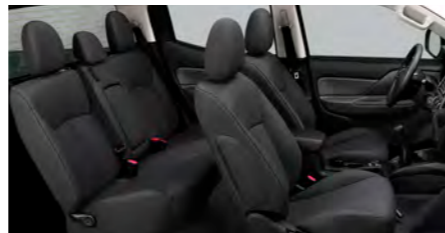

Double Cab

Instyle



Intense

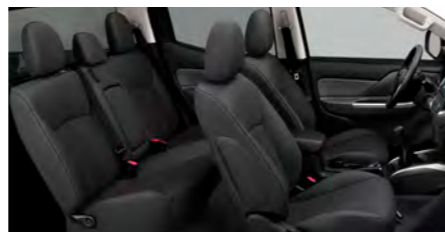

EXTERIOR COLOURS



Black Mica [X37]



Sterling Silver Metallic [U25]



Earth Green Metallic [F27]



Impulse Blue Metallic [D23]



Red Solid [R59]



Quartz Brown Metallic [C06]



Titanium Grey Metallic [U17]



White Pearl [W54]



White Solid [W32]

SEAT MATERIALS AND COLOURS

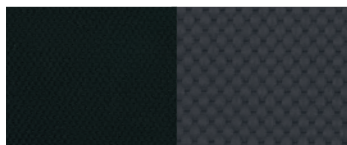

Fabric (Dark Grey)

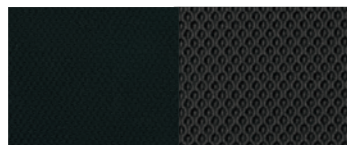

High Grade Fabric (Dark Grey)

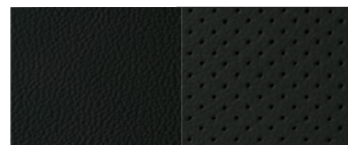

Leather (Black)

EXTERIOR AND INTERIOR COLOUR COMBINATIONS

Grade			Club Cab				Double Cab			
			4WD			2WD Hi-Rider	4WD			
			Inform/Invite	Intense	Instyle	Inform/Invite	Inform/Invite	Intense	Instyle	
Seat materials and colours	Fabric (Dark Grey)		■	-	-	■	■	-	-	
	High Grade Fabric (Dark Grey)		-	■	-	-	-	-	-	
	Leather (Black)		-	-	■	-	-	-	■	
Exterior colours	Black Mica	X37	■	■	■	■	■	■	■	
	Sterling Silver Metallic	U25	■	■	■	■	■	■	■	
	Earth Green Metallic	F27	■	■	■	■	■	■	■	
	Impulse Blue Metallic	D23	■	■	■	■	■	■	■	
	Red Solid	R59	■	■	■	■	■	■	■	
	Quartz Brown Metallic	C06	■	■	■	■	■	■	■	
	Titanium Grey Metallic	U17	■	■	■	■	■	■	■	
	White Pearl	W54	■	■	■	■	■	■	■	
White Solid	W32	■	■	■	■	■	■	■		

Note: Colours shown may differ slightly from actual colours due to printing process. Please consult your local Mitsubishi Motors dealer/distributor for actual colours.

Note: Equipment may vary by market. Please consult your local Mitsubishi Motors dealer/distributor for details.

STANDARD EQUIPMENT AND OPTIONS



Dark chrome grille



Chrome outer door handle

Chrome rear gate handle



Chrome power door mirror with side turn lamp



Auto rain sensor

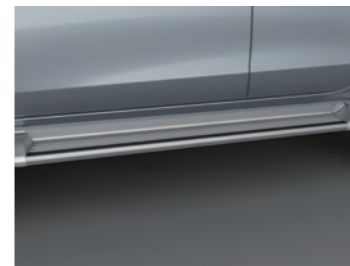

Plate-type side step



17-inch alloy wheel with 245/65R17 tyre



Wide 2DIN Audio LW/MW/FM, CD, MP3 player



Wide 2DIN Display Audio LW/MW/FM, CD, MP3 player



4-spoke leather-wrapped steering wheel with silver painted bezel

Genuine accessories



Note: Equipment and accessories may vary by market (and may vary from those shown or change without notice). Please consult your local Mitsubishi Motors dealer/distributor for details.

DIMENSIONAL VIEWS

Club Cab (4WD)

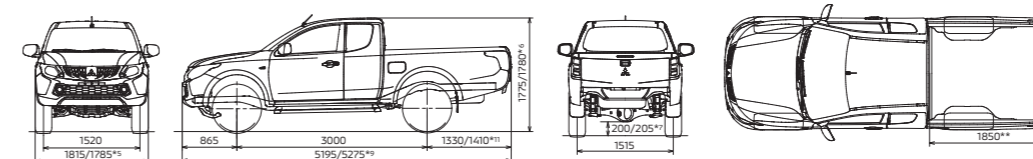

Double Cab (2WD Hi-Rider)

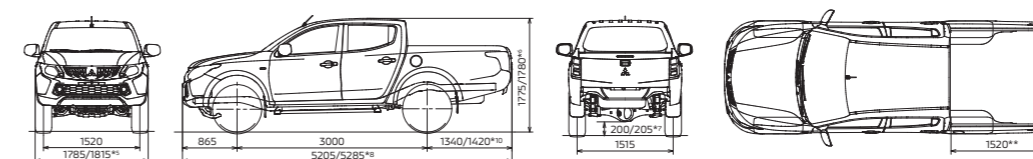

Double Cab (4WD)

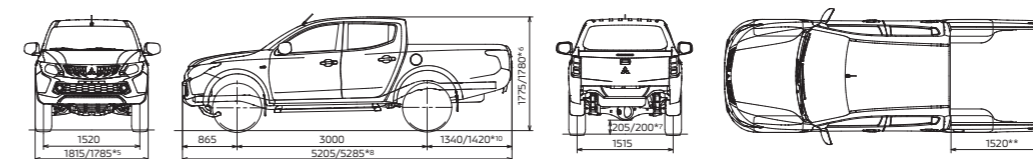

- *1 With rear step bumper
 - *2 With over fender
 - *3 Optional equipment
 - *4 With 245/70R16 tyres or 245/65R17 tyres
 - *5 Overall width: 1815mm with over fender, 1785 mm for without over fender
 - *6 Overall height: 1780mm with 245/70R16 tyres or 245/65R17 tyres, 1775mm with 205R16C tyres
 - *7 Minimum ground clearance: 205mm with 245/70R16 tyres or 245/65R17 tyres, 200mm with 205R16C tyres
 - *8 Overall length: 5205mm without bumper, 5285mm with bumper
 - *9 Overall length: 5195mm without bumper, 5275mm with bumper
 - *10 Rear overhang: 1340mm without bumper, 1420mm with bumper
 - *11 Rear overhang: 1330mm without bumper, 1410mm with bumper
 - ** Measured from bottom of bed
- Note: Hazardous driving may cause serious injury or vehicle damage. Please drive safely at all times.

All measurements in millimetres

